



120552-P1
Rev A, 2/97
Instruction Manual

MKS Type 250E Pressure/Flow Controller



WARRANTY

Type 250E Equipment

MKS Instruments, Inc. (**MKS**) warrants that the equipment described above (the "equipment") manufactured by **MKS** shall be free from defects in materials and workmanship for a period of one year from date of shipment and will for a period of two years from the date of shipment, correctly perform all date-related operations, including without limitation accepting data entry, sequencing, sorting, comparing, and reporting, regardless of the date the operation is performed or the date involved in the operation, provided that, if the equipment exchanges data or is otherwise used with equipment, software, or other products of others, such products of others themselves correctly perform all date-related operations and store and transmit dates and date-related data in a format compatible with **MKS** equipment. THIS WARRANTY IS **MKS'** SOLE WARRANTY CONCERNING DATE-RELATED OPERATIONS.

For the period commencing with the date of shipment of this equipment and ending one year later in the case of defects in materials and workmanship, but two years later in the case of failure to comply with the date-related operations warranty, **MKS** will, at its option, either repair or replace any part which is defective in materials or workmanship or with respect to the date-related operations warranty without charge to the purchaser. The foregoing shall constitute the exclusive and sole remedy of the purchaser for any breach by **MKS** of this warranty.

The purchaser, before returning any equipment covered by this warranty, which is asserted to be defective by the purchaser, shall make specific written arrangements with respect to the responsibility for shipping the equipment and handling any other incidental charges with the **MKS** sales representative or distributor from which the equipment was purchased or, in the case of a direct purchase from **MKS**, with the **MKS** home office in Andover, Massachusetts, USA.

This warranty does not apply to any equipment which has not been installed and used in accordance with the specifications recommended by **MKS** for the proper and normal use of the equipment. **MKS** shall not be liable under any circumstances for indirect, special, consequential, or incidental damages in connection with, or arising out of, the sale, performance, or use of the equipment covered by this warranty.

MKS recommends that all **MKS** pressure and flow products be calibrated periodically (typically every 6 to 12 months) to ensure accurate readings. When a product is returned to **MKS** for this periodic re-calibration it is considered normal preventative maintenance not covered by any warranty.

THIS WARRANTY IS IN LIEU OF ALL OTHER RELEVANT WARRANTIES, EXPRESSED OR IMPLIED, INCLUDING THE IMPLIED WARRANTY OF MERCHANTABILITY AND THE IMPLIED WARRANTY OF FITNESS FOR A PARTICULAR PURPOSE, AND ANY WARRANTY AGAINST INFRINGEMENT OF ANY PATENT.

MKS Type 250E Pressure/Flow Controller

Copyright © 1997 by MKS Instruments, Inc.

All rights reserved. No part of this work may be reproduced or transmitted in any form or by any means, electronic or mechanical, including photocopying and recording, or by any information storage or retrieval system, except as may be expressly permitted in writing by MKS Instruments, Inc.

Baratron® is a registered trademark of MKS Instruments, Inc., Andover, MA

Table of Contents

Safety Information.....	1
Symbols Used in This Instruction Manual.....	1
Symbols Found on the Unit	2
Safety Procedures and Precautions	3
Chapter One: General Information.....	5
Introduction	5
How This Manual is Organized.....	7
Customer Support.....	7
Chapter Two: Installation	9
How To Unpack the Type 250 Unit	9
Unpacking Checklist	9
Interface Cables	10
System Interface Cables	10
Generic Shielded Cable Description	11
Product Location and Requirements.....	13
Operating Environmental Requirements	13
Safety Conditions	13
Setup	14
System Design	14
Mounting Instructions	16
Interconnections	17
Electrical Information	19
Fuses.....	19
Grounding.....	19
Valve Connector.....	20
Input Connector.....	21
Interface Connector	22
Chapter Three: Overview.....	23

General Information	23
Multi-Gas Ratio Control.....	23
Front Panel Controls	24
Rear Panel Controls.....	26
Labels	27
Serial Number Label.....	27
Chapter Four: Operation	29
How To Setup the Controller.....	29
How To Use Manual Control.....	30
How To Tune-Up the Controller.....	30
How To Use the Bias Control.....	31
How To Use the Normal/Reverse Switch.....	32
How To Use External Control	32
How To Use the DVM Option.....	33
How To Use the Proportional Gain.....	33
How To Use the Multiple Set Point Option	34
Settings.....	34
Selection.....	34
Interconnections.....	35
How To Use the Process Limit Option	36
Controls.....	36
Interconnections.....	37
Chapter Five: Maintenance and Troubleshooting.....	39
General Information	39
Maintenance.....	39
How To Clean the Unit.....	39
How To Replace the Fuses.....	39
How To Perform the Controller Alignment Procedure.....	40
Troubleshooting	42
Appendix A: Product Specifications.....	45
Appendix B: Model Code Explanation.....	47
Model Code	47

Index 49

List of Figures and Tables

Figures

Figure 1: Preferred Method To Connect a Shielded Cable.....	12
Figure 2: Alternate Method To Connect a Shielded Cable	12
Figure 3: Standard Pressure Control Setup.....	18
Figure 4: Multi-Gas Ratio Control.....	18
Figure 5: Front Panel Controls	24
Figure 6: Rear Panel Controls.....	26
Figure 7: Serial Number Label	27
Figure 8: Process Limit Set Point Control	36

Tables

Table 1: Definition of Symbols Found on the Unit	2
Table 2: System Interface Cables.....	10
Table 3: Control Valves.....	16
Table 4: Fuse Information	19
Table 5: Valve Connector Pinout.....	20
Table 6: Input Connector Pinout.....	21
Table 7: Interface Connector Pinout	22
Table 8: Multiple Set Point Option Pinout.....	35
Table 9: Process Limit Option Pinout.....	37
Table 10: Test Point Voltages.....	41
Table 11: Troubleshooting Chart	43

Safety Information

Symbols Used in This Instruction Manual

Definitions of WARNING, CAUTION, and NOTE messages used throughout the manual.

Warning



The **WARNING** sign denotes a hazard. It calls attention to a procedure, practice, condition, or the like, which, if not correctly performed or adhered to, could result in injury to personnel.

Caution



The **CAUTION** sign denotes a hazard. It calls attention to an operating procedure, practice, or the like, which, if not correctly performed or adhered to, could result in damage to or destruction of all or part of the product.

Note



The **NOTE** sign denotes important information. It calls attention to a procedure, practice, condition, or the like, which is essential to highlight.

Symbols Found on the Unit

The following table describes symbols that may be found on the unit.















Definition of Symbols Found on the Unit			
			
On (Supply) IEC 417, No.5007	Off (Supply) IEC 417, No.5008	Earth (ground) IEC 417, No.5017	Protective earth (ground) IEC 417, No.5019
			
Frame or chassis IEC 417, No.5020	Equipotentiality IEC 417, No.5021	Direct current IEC 417, No.5031	Alternating Current IEC 417, No. 5032
			
Both direct and alternating Current IEC 417, No.5033-a	Class II equipment IEC 417, No.5172-a	Three phase alternating Current IEC 617-2 No. 020206	
			
Caution, refer to accompanying documents ISO 3864, No. B.3.1	Caution, risk of electric shock ISO 3864, No. B.3.6	Caution, hot surface IEC 417, No. 5041	

Table 1: Definition of Symbols Found on the Unit

Safety Procedures and Precautions

The following general safety precautions must be observed during all phases of operation of this instrument. Failure to comply with these precautions or with specific warnings elsewhere in this manual violates safety standards of intended use of the instrument and may impair the protection provided by the equipment. MKS Instruments, Inc. assumes no liability for the customer's failure to comply with these requirements.

DO NOT SUBSTITUTE PARTS OR MODIFY INSTRUMENT

Do not install substitute parts or perform any unauthorized modification to the instrument. Return the instrument to an MKS Calibration and Service Center for service and repair to ensure that all safety features are maintained.

SERVICE BY QUALIFIED PERSONNEL ONLY

Operating personnel must not remove instrument covers. Component replacement and internal adjustments must be made by qualified service personnel only.

GROUNDING THE PRODUCT

This product is grounded through the grounding conductor of the power cord. To avoid electrical shock, plug the power cord into a properly wired receptacle before connecting it to the product input or output terminals. A protective ground connection by way of the grounding conductor in the power cord is essential for safe operation.

DANGER ARISING FROM LOSS OF GROUND

Upon loss of the protective-ground connection, all accessible conductive parts (including knobs and controls that may appear to be insulating) can render an electrical shock.

GROUND AND USE PROPER ELECTRICAL FITTINGS

Dangerous voltages are contained within this instrument. All electrical fittings and cables must be of the type specified, and in good condition. All electrical fittings must be properly connected and grounded.

USE THE PROPER POWER CORD

Use only a power cord that is in good condition and which meets the input power requirements specified in the manual.

Use only a detachable cord set with conductors that have a cross-sectional area equal to or greater than 0.75 mm². The power cable should be approved by a qualified agency such as VDE, Semko, or SEV.

USE THE PROPER POWER SOURCE

This product is intended to operate from a power source that does not apply more voltage between the supply conductors, or between either of the supply conductors and ground, than that specified in the manual.

USE THE PROPER FUSE

Use only a fuse of the correct type, voltage rating, and current rating, as specified for your product.

DO NOT OPERATE IN EXPLOSIVE ATMOSPHERES

To avoid explosion, do not operate this product in an explosive environment unless it has been specifically certified for such operation.

HIGH VOLTAGE DANGER

High voltage is present in the cable and the sensor when the controller is turned on.

Chapter One: General Information

Introduction

The MKS Type 250E Pressure/Flow Controller will control any one of a variety of flow valves to accurately maintain a set pressure or flow. The 250 controller can provide a ± 15 VDC output and accepts inputs from a variety of pressure transducers and mass flow meters. Two controllers can be combined to provide two gas ratio control. The front panel controls allow selection of the input range, control loop tuning, and automatic and manual valve control. An error meter is provided on standard units to assist you in tuning the control loop. External signals can command the external set point, close the valve, or switch to the manual control. A DVM option is available to provide $4\frac{1}{2}$ place display of the control variable.

Typically, a pressure control system consists of three basic parts:

- The pressure sensor
- The controller and control valve
- The system whose pressure is to be controlled

The pressure sensor will usually be an MKS Baratron[®] Capacitance Manometer with an output of 0 to 10 VDC. Provision for other outputs (0 to 1 VDC or 0 to 100 mV) has been built into the controller so that other transducers may be used. The pressure (vacuum) system will consist of a chamber and a pumping system. Typically, users want to control the flow of gas entering the system while the system pressure is maintained by the 250 controller and a control valve.

The controller's new 9-pin Type "D" connector allows you to connect the unit to a variety of control valves (refer to Table 3, page 16). If you install the 250 controller into an existing system that uses the old (hex) connector cables, an adapter cable is required (refer to *Valve Connector*, page 20, for more information).

In more elaborate systems, the chamber pressure may be controlled with one controller while a known mass flow is admitted with the aid of a laminar flow element and its separate controller. The 250 controller takes the DC pressure signal, compares it to the set point, and positions the valve so that it drives the actual pressure to the set pressure. The 250 controller contains the three modes of control action found in most industrial controllers: proportional, derivative, and integral. Briefly, these functions are as follows:

1. **Proportional** gives a valve action (position) that is instantaneously a linear function of the error signal. For example:

$$\text{Signal to valve} = K_1 \times \text{Error} \quad (K_1 \text{ is adjustable by the gain pot})$$

2. **Derivative** action provides a signal to the valve that is proportional to the rate of change of the error signal. For example:

$$\text{Signal to valve} = K_2 \times \frac{d \text{Error}}{dt} \quad (K_2 \text{ is adjustable by the phase pot})$$

A simple description of this mode of control is that it provides an anticipation element, or the valve reaches its proper steady state position sooner than without derivative. This is apparent when setting up a system; the derivative or phase lead control tailors the under or overshoot. In other words, it cancels out the build-up of lags already built into the system.

3. **Integral** action provides an additional valve signal which is proportional to the length of time that an error signal exists. For example:

$$\text{Signal to valve} = \int d \text{Error} / dt$$

In other words, as time passes, the valve position changes which reduces the error signal to zero.

Note

The 250 controller has the integral and proportional control adjustments combined into one front panel GAIN pot.

How This Manual is Organized

This manual is designed to provide instructions on how to set up, install, and operate a Type 250 unit.

Before installing your Type 250 unit in a system and/or operating it, carefully read and familiarize yourself with all precautionary notes in the *Safety Messages and Procedures* section at the front of this manual. In addition, observe and obey all WARNING and CAUTION notes provided throughout the manual.

Chapter One, *General Information*, (this chapter) introduces the product and describes the organization of the manual.

Chapter Two, *Installation*, explains the environmental requirements and describes how to mount the instrument in your system.

Chapter Three, *Overview*, gives a brief description of the instrument and its functionality.

Chapter Four, *Operation*, describes how to use the instrument and explains all the functions and features.

Chapter Five, *Maintenance and Troubleshooting*, lists any maintenance required to keep the instrument in good working condition, and provides a checklist for reference should the instrument malfunction.

Appendix A, *Product Specifications*, lists the specifications of the instrument.

Appendix B, *Model Code Explanation*, describes the instrument's ordering code.

Customer Support

Standard maintenance and repair services are available at all of our regional MKS Calibration and Service Centers, listed on the back cover. In addition, MKS accepts the instruments of other manufacturers for recalibration using the Primary and Transfer Standard calibration equipment located at all of our regional service centers. Should any difficulties arise in the use of your Type 250 instrument, or to obtain information about companion products MKS offers, contact any authorized MKS Calibration and Service Center. If it is necessary to return the instrument to MKS, please obtain an ERA Number (Equipment Return Authorization Number) from the MKS Calibration and Service Center before shipping. The ERA Number expedites handling and ensures proper servicing of your instrument.

Please refer to the inside of the back cover of this manual for a list of MKS Calibration and Service Centers.

Warning



All returns to MKS Instruments must be free of harmful, corrosive, radioactive, or toxic materials.

This page intentionally left blank.

Chapter Two: Installation

How To Unpack the Type 250 Unit

MKS has carefully packed the Type 250 unit so that it will reach you in perfect operating order. Upon receiving the unit, however, you should check for defects, cracks, broken connectors, etc., to be certain that damage has not occurred during shipment.

Note

Do *not* discard any packing materials until you have completed your inspection and are sure the unit arrived safely.

If you find any damage, notify your carrier and MKS immediately. If it is necessary to return the unit to MKS, obtain an ERA Number (Equipment Return Authorization Number) from the MKS Service Center before shipping. Please refer to the inside of the back cover of this manual for a list of MKS Calibration and Service Centers.

Caution

Only qualified individuals should perform the installation and any user adjustments. They must comply with all the necessary ESD and handling precautions while installing and adjusting the instrument. Proper handling is essential when working with all highly sensitive precision electronic instruments.

Unpacking Checklist

Standard Equipment

- Type 250 Unit
- Type 250 Instruction Manual (this book)
- Power Cable

Optional Equipment

- Rack Mounting Kit:
RM-6
- Electrical Connector Accessory Kit:
250E-K1 (includes an I/O connector for the rear panel of the unit, a cover for the I/O connector, and a screw lock assembly for the I/O connector cover)
- System Interface Cables (refer to Table 2, page 10)

Interface Cables

As of January 1, 1996, most products shipped to the European Community must comply with the EMC Directive 89/336/EEC, which covers radio frequency emissions and immunity tests. In addition, as of January 1, 1997, some products shipped to the European Community must also comply with the Product Safety Directive 92/59/EEC and Low-Voltage Directive 73/23/EEC, which cover general safety practices for design and workmanship. MKS products that meet these requirements are identified by application of the CE Mark.

To ensure compliance with EMC Directive 89/336/EEC, an overall metal braided shielded cable, properly grounded at both ends, is required during use. No additional installation requirements are necessary to ensure compliance with Directives 92/59/EEC and 73/23/EEC.

Note



1. Overall metal braided shielded cables, properly grounded at both ends, are required during use to meet CE Mark specifications.
2. To order metal braided, shielded cables, add an “S” after the cable type designation. For example, to order a standard cable to connect the 250 unit to a Type 627 transducer, use part number CB258-1-10; for a metal braided, shielded cable, use part number CB258S-1-10.

System Interface Cables

The system interface cables include cables to connect the 250 controller to a transducer or to a valve, as well as the adapter cable necessary to replace a 250A-C unit with a 250E unit.

System Interface Cables		
To Connect the 250 Unit To...	Use the MKS Cable...	
	Standard	Shielded
270/690 system	CB250-7-3	CB250S-7-3
122, 124, 223, 622, and 623 transducers	CB254-2-10	CB254S-2-10
221 transducer	CB254-1-10	CB254S-1-10
220 transducer	CB254-10-10	CB254S-10-10
127, 624, 626, 627 transducers and 179, 258, 358, 558 mass flow meters	CB258-1-10	CB258S-1-10
128, 625, and 628 transducers	CB128-2-10	CB128S-2-10
PDR-C-1C/2C, PDR-D-1, and PDR-5B power supply/readouts	CB254-17-6	CB254S-17-6
120 transducer with a separate power connector	CB120-3-10	CB120S-3-10

Table 2: System Interface Cables
(Continued on next page)

System Interface Cables (Continued)		
To Connect the 250 Unit To...	Use the MKS Cable...	
	Standard	Shielded
148, 148J, 154, 248 valves	CB251-2-10	CB251S-2-10
153 PCS	CB153-2-10	CB153S-2-10
Allows replacement of a 250A-C unit with a 250E unit (refer to <i>Valve Connector</i> , page 20)	CB250-12-1	CB250S-12-1

Table 2: System Interface Cables

Generic Shielded Cable Description

MKS offers a full line of cables for all MKS equipment. Should you choose to manufacture your own cables, follow the guidelines listed below:

1. The cable must have an overall metal *braided* shield, covering all wires. Neither aluminum foil nor spiral shielding will be as effective; using either may nullify regulatory compliance.
2. The connectors must have a metal case which has direct contact to the cable's shield on the whole circumference of the cable. The inductance of a flying lead or wire from the shield to the connector will seriously degrade the shield's effectiveness. The shield should be grounded to the connector before its internal wires exit.
3. With very few exceptions, the connector(s) must make good contact to the device's case (ground). "Good contact" is about 0.01 ohms; and the ground should surround all wires. Contact to ground at just one point may not suffice.
4. For shielded cables with flying leads at one or both ends; it is important at each such end, to ground the shield *before* the wires exit. Make this ground with absolute minimum length. Refer to Figures 1 and 2, page 12. (A ¼ inch piece of #22 wire may be undesirably long since it has approximately 5 nH of inductance, equivalent to 31 ohms at 1000 MHz). After picking up the braid's ground, keep wires and braid flat against the case. With very few exceptions, grounded metal covers are not required over terminal strips. If one is required, it will be stated in the Declaration of Conformity or in the instruction manual.
5. In selecting the appropriate type and wire size for cables, consider:
 - A. The voltage ratings;
 - B. The cumulative I^2R heating of all the conductors (keep them safely cool);
 - C. The IR drop of the conductors, so that adequate power or signal voltage gets to the device;
 - D. The capacitance and inductance of cables which are handling fast signals, (such as data lines or stepper motor drive cables); and
 - E. That some cables may need internal shielding from specific wires to others; please see the instruction manual for details regarding this matter.

Example 1: Preferred Method To Connect Cable
(shown on a transducer)

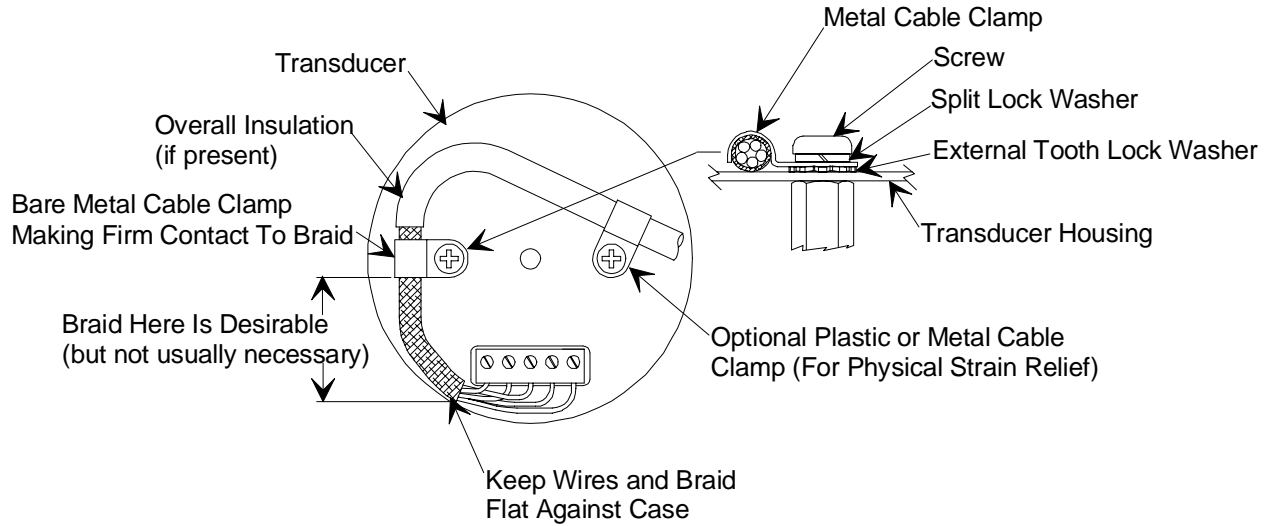

Figure 1: Preferred Method To Connect a Shielded Cable

Example 2: Alternate Method To Connect Cable
(shown on a transducer)

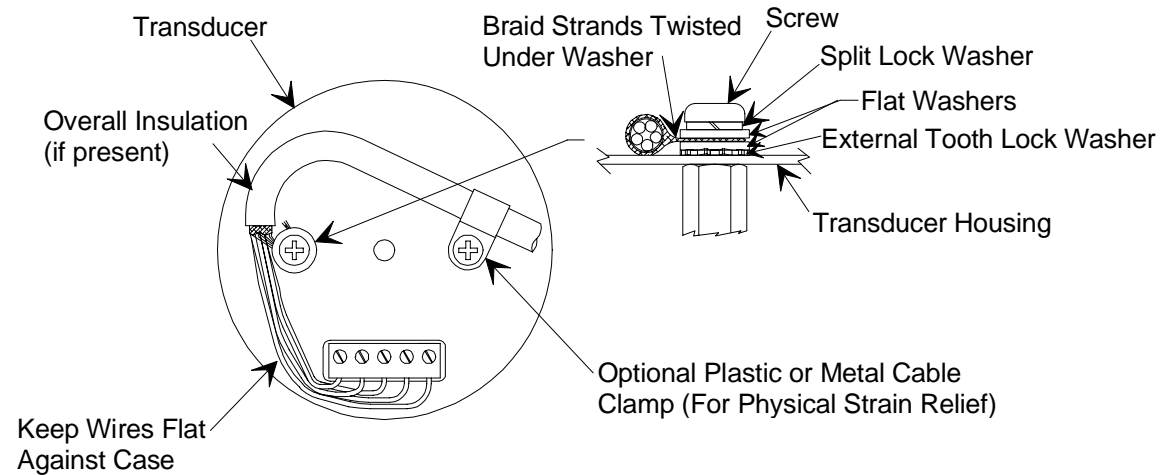

Figure 2: Alternate Method To Connect a Shielded Cable
(Use When Cable Clamp is Not Available)

Product Location and Requirements

The Type 250 unit meets the following criteria:

- POLLUTION DEGREE 2 in accordance with IEC 664
- Transient overvoltages according to INSTALLATION CATEGORY II

Operating Environmental Requirements

- Ambient Operating Temperature: 0° to 40° C (32° to 104° F)
- Main supply voltage fluctuations must not exceed $\pm 10\%$ of the nominal voltage
- Ventilation requirements include sufficient air circulation
- Connect the power cord into a grounded outlet
- Power: 100 to 120 VAC nominal @ 50/60 Hz
220 to 240 VAC nominal @ 50/60 Hz
50 VA maximum (50/60 Hz)

Safety Conditions

The 250 unit poses no safety risk under the following environmental conditions.

- Altitude: up to 2000 m
- Maximum relative humidity: 80% for temperatures up to 31° C, decreasing linearly to 50% at 40° C

Setup

System Design

There are several considerations that must be dealt with before start-up:

Valve Selection

The correct valve must be selected to allow a reasonable fast time response.

For example:

Assume a system whose pumping speed is 150 liters/sec. and whose volume is 100 liters. This means that the pump down time constant (T.C.) will be 0.7 seconds. To control at 100 μ , or 0.1 Torr, with an up time constant equal to the down time constant (in the practical case this will rarely happen), the quantity of gas that the pump is able to draw out at this pressure is 150 liters/sec. x 100 μ , or 15000 μ L/sec. Converting this to sccm: = 1184.

If the 1000 sccm valve is chosen, it will never get up to 100 μ because the pump is slightly faster than the valve (at 100 μ). The valve goes wide open and the pressure drops to the point where the valve throughput equals that of the pump (somewhat less than 100 μ pressure). Two things can be done to make the system work.

The first, and proper course of action (which maintains the system's natural fast response), is to select a bigger valve (2000 sccm) which provides more gas than the pump can extract. If overshoot occurs, the down T.C. will be a combination of the pump and chamber T.C., modified by the controller's T.C. as control point is approached. Basically, if a large valve is selected, the speed-up control will be a function of the controller's speed (incoming flow); the down control will be a function of the pump's speed.

The second course of action is to reduce the pumping speed. However, this approach (usually realized by partially closing a valve) slows down the entire system.

Pressure Range

The range of pressures over which the system will work must be selected.

It is recommended that this be limited to 100 to 1; although pressures five decades apart have been controlled with a single valve.

Lags

Lags must be removed.

If lags (delays) are built into a system, stabilization will be difficult or impossible. Lag may be introduced pneumatically in two areas: the tubing to the sensor and the tubing to the valve. **Both tubing runs must be less than 6 inches long and no less than ¼ inch in diameter.** Make sure the fittings do not introduce extra lags (internal small drilled passages). Other lags such as antichambers off the main vacuum chamber may also cause problems and must be kept to a minimum.

If a 270/690 type system is used for pressure measurement, the most likely cause of lags is allowing the indicator switch on the 270 signal conditioner to be placed in the wrong position. This switch must be in the NORMAL position.

Choking

Another important consideration, is a condition that is peculiar to diffusion pumps, called choking. If too much gas is introduced at too high a pressure, the pumping speed becomes erratic and changes radically. This behavior is easily recognized by lack of stability and pneumatic noise, sometimes making control impossible. Reducing the flow to the pump is the only solution.

Note



Diffusion pumps should never be operated at inlet pressures above which the “top jet” will experience a pressure in excess of 5×10^{-4} Torr.

Mounting Instructions

Controller

The 250 can be mounted on any instrument panel or placed on a bench. The mounting position is not critical and it will operate properly in any position. While the unit is designed and tested to operate with no air circulation, it will run much cooler if the top air slots are clear to allow convection air circulation. No special precautions are needed to protect the unit from ordinary mechanical shock and vibration. A rack mounting kit (RM-6) is available from MKS for single or dual unit rack mounting.

Valve

The 250 unit can control a variety of valves, as listed in Table 3. The control valve should be connected to the 250 controller using piping or hose as large in diameter and as short in length as possible. The valve can be changed at any time as long as the proper cable is used. Refer to the appropriate manual for mounting instructions.

Control Valves					
Type of Valve	Manufacturer	Manufacturer Part Number	MKS Part Number	Flow Range (sccm)	Connection Cable or Connector
Piezoelectric	Veeco	PV-10	170M-49	0 - 200	Consult factory
Solenoid	MKS	148, 148J, 154, 248	148, 148J, 154, 248	0 - 10 to 0 - 50K	CB-251-2-10
Solenoid	Brooks	5835A	251-xx	0 - 50K	Consult factory
Solenoid	Balzers	RME010	255	0 - 40K	Consult factory

Table 3: Control Valves

Transducer

Any pressure transducer which delivers at least 0.1 Volt full scale, can be used as the feedback element for total pressure control (refer to *Optional Equipment*, page 9).

The pressure transducer should be mounted so that it is firmly supported, while at the same time, isolated from any vibration.

Mass Flow Meters

Any mass flow meter (MFM) which delivers at least 5 Volt full scale can be used with the 250 controller depending on the flow rates, types of gas, etc. needed in the control system (refer to *Optional Equipment*, page 9). Refer to the appropriate MFM manual for mounting instructions.

Interconnections

Figures 3 and 4, page 18, show typical piping and cable interconnection diagrams. Figure shows the usual setup for standard pressure control. Figure 4 shows a setup for multi-gas ratio control.

Connect the valve and sensor to the chamber using short connections with minimum restrictions. Six inches of ¼" tubing should be maximum. Never reduce the tubing size below that of the valve and transducer.

Connect the valve and transducer to the back of the controller and set the valve mode switch (CMAE) to CLOSE (refer to *Rear Panel Controls*, page 26).

Figure 3: Standard Pressure Control Setup

Figure 4: Multi-Gas Ratio Control

Electrical Information

Fuses

The line fuses protect the internal circuitry; both sides of the line are fused. The fuse values are listed in Table 4.

Fuse Information	
Voltage	Fuse Type
115 VAC	0.50 A (T) / 250 V / 5 x 20 mm
230 VAC	0.25 A (T) / 250 V / 5 x 20 mm

Table 4: Fuse Information

Caution



Disconnect the line cord from the AC power outlet before replacing the fuse.

Grounding

For protective earthing, plug the power cord into a properly grounded outlet.

Valve Connector

The 9-pin Type “D” connector allows you to connect the 250 unit to a control valve, using cable CB251-2-10. If you are installing the 250 controller into an existing system that uses the old (hex) connector cables, an adapter cable is required. Use cable CB250-12-10 or CB250S-12-10 to replace a Type 250A-C controller with the Type 250E controller.

Note



Overall metal braided shielded cables, properly grounded at both ends, are required during use to meet CE Mark specifications.

Different pins on the connector are used for various types of valves (Piezoelectric or solenoid type valves). The different valve cables listed in Table 3, page 16, are wired to connect to the proper voltages.

Valve Connector Pinout	
Pin	Assignment
1*	Voltage High
2*	Voltage Low (Chassis)
3	Chassis ground
4	No Connection
5	No Connection
6**	Current High
7**	Current Low
8	No Connection
9	Chassis Ground
* For Piezoelectric type valves	
** For solenoid type valves	

Table 5: Valve Connector Pinout

Note



The “No Connection” pin assignment refers to a pin with no internal connection.

Input Connector

This 14-pin Amphenol connector allows you to connect the 250 controller to a transducer. It provides $\pm 15V$ power and accepts the input pressure signal from the transducer.

Input Connector Pinout	
Pin	Assignment
1	(+) Pressure Input
2	Reserved
3	D.C. Signal Output (0 to 10 Volts) Duplicate of transducer signal
4	Signal Return (Analog Ground)
5	Reserved
6	Reserved
7	Reserved
8	(-) Input (Connect to Analog Ground (Pin 12) at input source)
9	Reserved
10	Reserved
11	$\pm 15V$ Output
12	Power Supply Ground (Analog Ground)
13	-15V Output
14	Chassis

Table 6: Input Connector Pinout

Note



The “Reserved” pin assignment refers to a pin with an internal connection which may be assigned a function in the future.

Interface Connector

This 14-pin Amphenol connector provides access to the miscellaneous outputs, $\pm 15\text{V}$ power, and external inputs to the 250 controller. Since there are a limited number of spare pins on the Interface connector, the exact pinout depends on which options are installed.

- Refer to Table 8, page 35, for the Multiple Set Point Option pinout
- Refer to Table 9, page 37, for the Process Limit Option pinout

Interface Connector Pinout	
Pin	Assignment
1	(+) Set Point
2	Reserved
3	Digital Ground (Common for Manual and Close)
4	Manual (Connect to Pin 3 to put in Manual)
5	Close (Connect to Pin 3 to put in Close)
6*	Controller Output (0 to 10 Volts - used for pump speed control)
7	Reserved
8	(-) Set Point [Connect to analog ground (Pin 12) at input source]
9*	Pressure Control Signal (PCS) (10 V full scale)
10*	D.C. Signal (0 to 10 Volts) Duplicate of transducer signal
11	+15V Output
12	Power Supply Ground (Analog Ground)
13	-15V Output
14	Chassis
<i>*Items are on standard and DVM units.</i>	

Table 7: Interface Connector Pinout

Note



The “Reserved” pin assignment refers to a pin with an internal connection which may be assigned a function in the future.

Chapter Three: Overview

General Information

The Type 250 controller is a versatile controller capable of pressure, flow, or flow ratio control. It is used for pressure control when a pressure transducer provides the feedback signal, and flow control when a mass flow meter provides the feedback. If a second mass flow meter is used for external set point, flow *ratio* is controlled.

The purpose of a controller is to compare the required pressure level (set point) with the actual pressure level (feedback input) and make appropriate corrections in the pump speed (via adjustments on the valve) until the actual pressure equals the required pressure.

Figure 3, page 18, shows a simple pressure control loop consisting of an input signal, controller output valve, vacuum system, and pressure transducer. The pressure transducer converts pressure to an electrical signal which is compared in the controller to the required signal (in most cases, a precision pot whose voltage is changed by rotating the dial). Note that in a simple pressure loop, the flow rate is not measured because it is unnecessary.

Any error between the actual (feedback) and required (set point) signals is amplified by the controller and fed to the valve. For example, if the pressure is higher than the set point, the controller reduces the current to the valve, which reduces the flow into the vacuum system, subsequently reducing the pressure.

An additional requirement of the controller is to provide a stabilizing or tuning control. This control (PHASE LEAD) allows you to compensate for the different delays, or lags, that occur in various systems.

Multi-Gas Ratio Control

When controlling multiple gases, the 250 unit operates in a similar manner to the single gas system, except that a 0 to 10 Volt Pressure Control Signal (PCS) from the 250 controller is used to control the set point signals to multiple mass flow controllers (MFC).

As in single gas systems, if the pressure is below the set point, the controller increases the PCS which increases all flows in a predetermined ratio. The exact ratio of the flow is determined using a power supply/display unit such as the 247, 647, or multiple 246 units.

Front Panel Controls

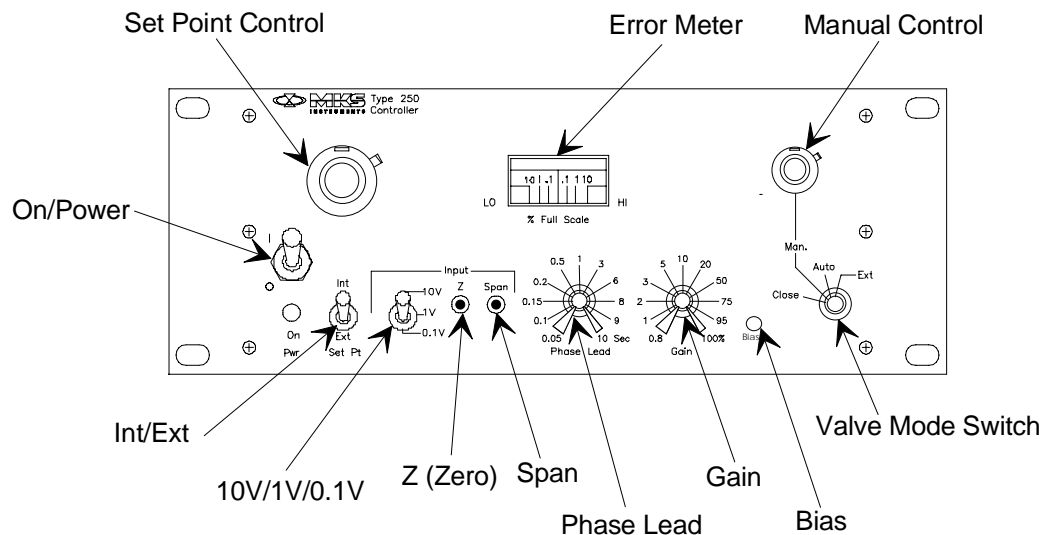

Figure 5: Front Panel Controls

ON/POWER - Controls the AC power to the 250 controller. The LED indicator below it indicates when the power is on, that is, the plug is in and the fuse is alive.

INT/EXT - Selects either the internal (front panel) set point control or an external set point voltage.

10V/1V/0.1V - Selects the full scale range of the input voltage. As shipped, the 250 controller is calibrated for $\pm 0.25\%$ on the 10V range. The 1V and 0.1V ranges are calibrated for $\pm 2\%$, but can be adjusted closer with the span pot (refer to SPAN below).

Z (ZERO) - Allows offsetting for any initial zero errors in the transducer. With zero pressure (or flow) on the transducer and the set point at zero, adjust the zero pot for zero error on the error meter (or 0000 reading on the optional DVM).

SPAN - Allows precise adjustment of the full scale input voltage. Any range can be accurately calibrated for any voltage within its range by applying an accurate full scale voltage, turning the set point to full scale, and adjusting the SPAN control for zero error. For example, with a 5.00 Volt input, put the SPAN select on 10V and adjust the SPAN for zero error on the error meter (or 10000 reading on the optional DVM).

PHASE LEAD - The PHASE LEAD control allows you to compensate for the major lag in the control system. In pressure systems, this lag is generally caused by the restrictions in the gas flow line and the capacity of the pressure vessel. In flow systems, the lag is generally the time constant of the mass flow meter. Typical settings are 0.5 to 5 seconds. A setting that is too low will cause overshoot; too high will cause a slow response.

GAIN - The GAIN setting determines the overall gain of the controller and should be as high as possible without making the system unstable. The higher the gain, the smaller the dead band. If some overshoot is tolerable, better control (less dead band) can be achieved. Typical settings are 20 to 50%.

BIAS - The BIAS control adjusts the minimum voltage or current applied to the valve in the AUTO, EXT, and MANUAL positions. Proper adjustment of the bias will improve the settling time at initial turn-on, and reduce undershooting during oscillations or large changes in flow (refer to *How To Use the Bias Control*, page 31).

VALVE MODE SWITCH - The VALVE MODE SWITCH selects the method of valve control. In CLOSE, all signal is removed from the valve. The MANUAL control determines the valve signal (voltage or current). In AUTO, the controller drives the valve according to the error signal and the phase and gain controls. In EXT, the controller is in automatic unless one of the external control lines (MANUAL or CLOSE) is connected to digital ground. If both MANUAL and CLOSE are connected to digital ground, the “Close” operation will dominate. External commands will not affect the 250 controller unless the CMAE switch is in the EXT position.

MANUAL - The MANUAL control allows you to control the valve signal (voltage or current) directly, without worrying about set point setting, process variables, etc. Note that with most valves, the flow output is not proportional to valve signal.

A signal of from 40 to 90% is needed to start the valve opening and it will be completely open with an additional 10%.

ERROR METER - Meter indication of the difference between the set point and the actual pressure, or flow. The ERROR METER is useful when tuning the PHASE or GAIN controls because it shows overshoot and oscillation around the proper control level.

The ERROR METER is not provided on controllers with the DVM option.

SET POINT - The SET POINT control is your input to the 250 controller. The dial represents the fraction of the full scale pressure range. The SET POINT is set to the desired pressure, or flow, and the controller maintains that pressure while in the AUTO or EXT mode. For example, if the transducer’s full scale pressure is 1 Torr and the SET POINT is set for 0.432 (4/32 indicated on the dial), then the 250 controller maintains a pressure of 432 microns. The 1V range can be used to increase the resolution at the lower 10% of a 10V range. In the example above, if the 1V range is used (100 microns full scale), the controller maintains 43.2 microns.

When operating with external set point input (0 to 5V), the front panel SET POINT control should be fully clockwise (CW).

Rear Panel Controls

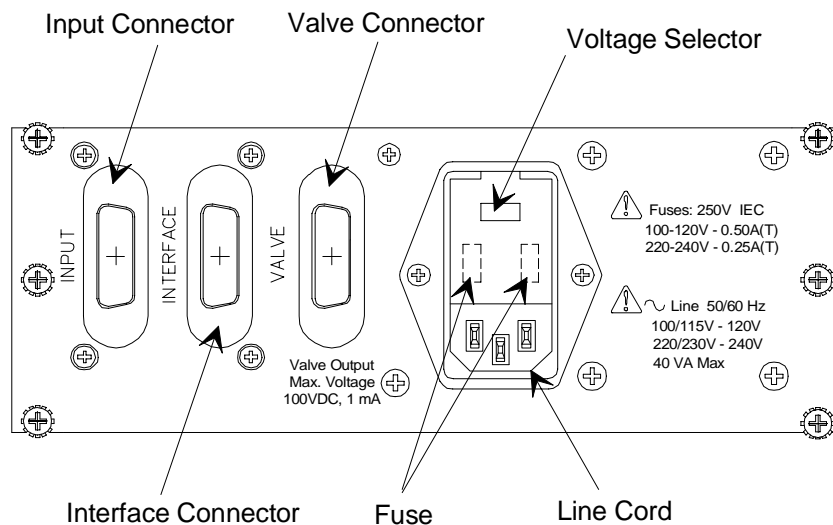

Figure 6: Rear Panel Controls

LINE CORD - Provides 115 or 230 VAC to the 250 controller. For protective earthing, plug the power cord into a properly grounded outlet.

VOLTAGE SELECTOR - Should be set to the proper input voltage before the line cord is plugged in and the power turned ON.

FUSE - Line fuse to protect internal circuitry. Both sides of the line is fused.

Caution



Disconnect line cord from the AC power outlet before replacing the fuse.

VALVE - The control valve connects to the 250 controller through a 9-pin female Type "D" connector. Use cable CB251-2-10 to connect the valve to the controller. Different pins on the connector are used for various types of valves. The different valve cables are wired to connect to the proper voltages.

Note



If you are installing the 250E controller into an existing system that uses the old (hex) connector cables, an adapter cable is required. Use adapter cable CB250-12-1 or CB250S-12-1 to replace a Type 250A-C controller with the Type 250E controller. Refer to Table 5, page 20, for the Valve connector pinout.

INTERFACE - This 14-pin Amphenol connector provides access to the miscellaneous outputs, $\pm 15V$ power, and external inputs to the controller. Refer to Table 7, page 22, for the Interface connector pinout.

INPUT - This 14-pin Amphenol connector provides $\pm 15V$ power and accepts the input pressure signal. Refer to Table 6, page 21, for the Input connector pinout.

Labels

Serial Number Label

The Serial Number label, located on the side of the instrument, lists the serial number and the product model number of the unit.



Figure 7: Serial Number Label

The instrument is identified as “250E - X - Y - Z”, where:

- 250E = Type number
- X = Number of set point controls
- Y = Display Option
- Z = Option

Refer to *Appendix B: Model Code Explanation*, page 47, for more information.

This page intentionally left blank.

Chapter Four: Operation

How To Setup the Controller

Before plugging in the AC line cord, turn the power switch OFF and perform the following steps:

1. Ensure that the voltage selector on the rear panel is in the proper position and that the fuse has the proper rating.
The power and fuse ratings are listed in *Appendix A: Product Specifications*, page 45.
2. Place the INT/EXT and RANGE switches in the proper positions and turn the SET POINT and MANUAL controls to zero.
3. Plug in the power cord and turn on the POWER.
The power LED should light.
4. Allow the system to warm up for at least 15 minutes.
5. Ensure the chamber pressure is less than the resolution of the transducer, and zero the controller by setting the SET POINT at zero (fully CCW) and adjusting the ZERO control for zero error on the meter (or adjust for 0000 reading on the optional DVM).

Note

1. Temperature-controlled transducers, such as the 270/690 and 127 or 128 units, need approximately four hours to completely stabilize.
 2. If a 270 signal conditioner is used, the 270 Sensor Zero control can be used for zeroing; the RESPONSE switch should be in the NORMAL position.
-

6. Turn ON the gas source.

How To Use Manual Control

The 250 controller has a MANUAL control which, when properly adjusted, should make the initial valve turn-on quick and easy.

Place the valve selector in MANUAL and increase the MANUAL control setting. During the first few turns nothing will happen to the flow (or pressure in the system). The numbers on the MANUAL control are meaningless except to allow the operator to return to a known position.

When the signal to the valve is large enough to exceed the valve offset, the valve begins opening. At this point you can fine-tune the MANUAL control to set a flow into the system to produce the desired pressure. Leave the MANUAL control in the set position in order to produce the quickest and smoothest transition from CLOSE to AUTOMATIC.

How To Tune-Up the Controller

Turning the valve mode switch (CMAE) to AUTO puts the controller into action. If the SET POINT control is set for the same pressure (or flow) that the MANUAL control had established, then the transition from MANUAL to AUTO should be smooth and bumpless.

To tune the controller, turn the GAIN up until 0.1% oscillations are apparent. Minimize oscillation amplitude using PHASE LEAD settings. When oscillations cease, turn up the GAIN and readjust the PHASE LEAD if necessary. Check the settings by changing the SET POINT control. Optimum response is for the error to reduce to zero quickly, but with no overshoot. If the pressure oscillates (error meter swings from positive to negative) the GAIN is too high. The GAIN may be increased later when the PHASE LEAD is properly adjusted. If the pressure overshoots, but settles to the proper value, more PHASE LEAD is required. If the pressure is slow rising to the proper value, less PHASE LEAD is required. If the pressure settles at a steady value, which is other than the set point (greater than $\pm 0.25\%$ error), more GAIN is needed.

When making final adjustments, move the controls less than 10° to prevent overcontrolling. Various pressures will require different settings of GAIN and PHASE LEAD although pressures up to a decade apart may be controlled using the same settings. Speed will be sacrificed for lower pressures.

Note

On controllers with the DVM option, the system error will have to be calculated by subtracting the set point value from the displayed value.

How To Use the Bias Control

The BIAS control establishes a floor, or minimum, signal level to the valve which prevents the integrator from “winding up” or going too far into saturation. The signal to the valve consists of the bias level plus the controller signal. In MANUAL, the controller signal is determined by the MANUAL control. In AUTO, the controller signal is determined by the error signal and the GAIN and PHASE LEAD controls.

For good control, it is important that the BIAS be set as high as possible, particularly during pressure transients. The factory BIAS adjustment is for 35% of output.

If the controller cannot turn the valve completely off, the BIAS may be set too high. If the BIAS control needs adjustment, do the following:

1. Turn the MANUAL control to zero.
2. Turn the CMAE switch to CLOSE and check that there is no flow and the system can be pumped to zero pressure.
3. Turn the CMAE switch to MANUAL; there should still be no flow.
4. If there is flow, turn the BIAS control counterclockwise (CCW) until the flow stops and then two more turns CCW.
5. If there is no flow, turn the BIAS control clockwise (CW) until flow just appears and then back off (CCW) two turns.

How To Use the Normal/Reverse Switch

Most applications will require that when the pressure (or flow) is greater than the set point, the valve should have less drive to return the process to the proper value. This is “normal” operation and assumes that the output of the pressure (or flow) transducer *increases* positively for increasing pressure (or flow).

Inside the 250 controller, at approximately the center of the P.C. board, is a slide switch which can be used to obtain “reverse” action from the controller.

This switch should be in the REVERSE position if either:

- The pressure (or flow) transducer output *decreases* for increasing pressure (or flow)
- The valve drive signal *increases* when the pressure (or flow) is greater than the set point (such as exhaust control)

How To Use External Control

The 250 unit can be externally controlled with two inputs on the Interface connector. Refer to Table 7, page 22, for the Interface connector pinout.

Note



The front panel mode switch *must* be in the EXT position for the external inputs to be accepted.

Shorting the CLOSE input (Pin 5) to digital ground (Pin 3) will cause all signals to be removed from the valve and it will close.

Shorting the MANUAL input (Pin 4) to digital ground (Pin 3) will put the controller in the Manual mode. Whatever signal dialed into the Manual control, plus bias will be applied to the valve.

Shorting both the CLOSE and MANUAL inputs to ground will put the controller in Close. If Pins 4 or 5 are not shorted to Pin 3, the 250 controller will provide automatic control of pressure (or flow) to the selected set point.

How To Use the DVM Option

The 250 controller can optionally be supplied with a 4½ place DVM to display the controlled parameter (pressure or flow). The display is from 0000 to 10000 and the decimal point can be positioned at any convenient location with switches inside the controller.

To check the calibration of the DVM, input 0.000 Volts at the Input connector and adjust the ZERO control on the front panel for a reading of 0000 on the DVM. Make sure the Range switch (10V, 1V, 0.1V) is in the proper position. If the full scale input is greater than 1 Volt, then the 10 V range must be used. Now apply full scale input voltage (typically 10 Volts or 5 Volts) and adjust the front panel SPAN control for a reading that corresponds to the full scale of the transducer.

For example, a pressure transducer where 10V = 1 Torr, input 10.00 Volts and adjust the SPAN for a reading of 10000. For a flow transducer where 5V = 200 sccm, input 5.00 Volts and adjust the SPAN for 2000 (the set point pot is useable only over the lower 20%).

To select the decimal point, remove the top cover and locate the decimal point switch on the main P.C. board (labeled S7) near the power transformer. The switch is labeled for decimal point locations; only one should be ON at a time.

How To Use the Proportional Gain

In some unusual control applications, the two front panel controls GAIN and PHASE LEAD may not provide enough adjustment to tune the control loop. A typical application is where the feedback input is ion beam current rather than pressure or flow. In these applications, the PROPORTIONAL GAIN control *inside* the controller may provide enough additional control range to stabilize the loop.

The PROPORTIONAL GAIN control (R69) is a 25-turn trim pot on the right side as you look at the front panel about half-way back on the main P.C. board. To try this control, turn it about 10 turns clockwise and then tune the front panel controls (refer to *How To Tune-Up the Controller*, page 30). If this improves the loop stability and additional adjustment is desired, turn the PROPORTIONAL GAIN control several turns in each direction. The PROPORTIONAL GAIN control is very fine so several turns can be made without overcontrolling.

How To Use the Multiple Set Point Option

The Multiple Set Point Option (MSO) provides up to four front panel set point pots which can be selected either from the front panel, or remotely. When selected, each set point pot provides a precision reference for the controller, which will maintain the control pressure (or flow) at the preset level.

The set point pots are preset with up to four levels which can be selected by using the front panel selector switch. In the REMOTE position, fully close and a manual signal can be selected, and an external programmer can select any of the preset levels by activating a digital control line.

Settings

The MSO set point pots are 10-turn precision units with calibrated dials. Each pot covers the full range of the feedback transducer (0 to 100%). The controllers are calibrated for a precise 10 Volt full scale and should not need adjustment if a 10 Volt transducer is used. If other full scale voltage transducers are used, refer to the SPAN adjustment procedure, described in *Front Panel Controls*, page 24.

The set point controls are your input to the controller. The dial represents the fraction of full scale range. For example, if the transducer's full scale pressure is 10 Torr, and a set point is set for 0.342 (3/42 indicated on the dial), when the set point is selected, the controller will maintain a pressure of 3.42 Torr in either AUTO or EXT (with no overriding) commands.

Each set point pot should be set to a pressure (or flow) required by the process. The pots can be adjusted anytime, whether they are ON or OFF.

Selection

When the front panel switch selects a particular set point, all remote select signals are ignored. In REMOTE, all remote select signals are selected and ***it is important that only one set point be selected at a time.***

As normally shipped, the remote set point select lines are wired for negative true; a short-to-digital ground will select the appropriate set point. When the lines are not shorted to ground, they are pulled up to +5 V with a 10 K resistor.

If positive true logic is desired, that is, a positive signal (5V) will select the appropriate set point; then a jumper should be installed near R23 at the rear of the MSO P.C. board. ***Note that if positive true logic is used, all unused set point select lines must be held at digital ground.***

As each set point is selected, a light above the set point pot is illuminated.

Interconnections

The remote set point select lines are brought out on the Interface connector, and are listed in Table 8. The *digital* ground should be connected to the circuit ground of the digital instrument that is selecting set points. Refer to Table 7, page 22, for the complete Interface connector pinout.

Multiple Set Point Option Pinout	
Interface Connector Pin	Assignment
3	Digital Ground
6	Set Point 1
7	Set Point 2
9	Set Point 3
10	Set Point 4

Table 8: Multiple Set Point Option Pinout

Note



The External Set Point Signal is not applicable on units with the Multiple Set Point Option. Also, the use of Pins 6, 9, and 10 for the MSO precludes bringing out the Controller Output, Pressure Control Signal, and D.C. Signal.

How To Use the Process Limit Option

The Process Limit Option (PLO) provides a logic signal (+5V) and relay closure when the controller error deviates from zero by more than the process limit. The process limit can be set by an internal control to any range from ± 0.5 to $\pm 100\%$. An LED indication is provided on the board to assist in setup.

The PLO board compares the absolute value of the error signal to the process limit setting. If the error is less than the setting, the relay is CLOSED, the LED is green, and the logic level is low (0 Volts). If the error signal is greater than the process limit setting, the relay is OPEN, the LED is red, and the logic level is high (+5 Volts). If power is lost, the relay will open, the LED will be off and the logic level will appear high.

Note



For some customers, the logic output is reversed from that described above; *within* process control gives a high output (+5 Volts) and *out-of-control* gives a low output (0 Volts).

Controls

The process limit set point control is a single-turn pot which is non-linear to provide greater resolution at the lower percentage settings. The approximate settings are shown in Figure 8.

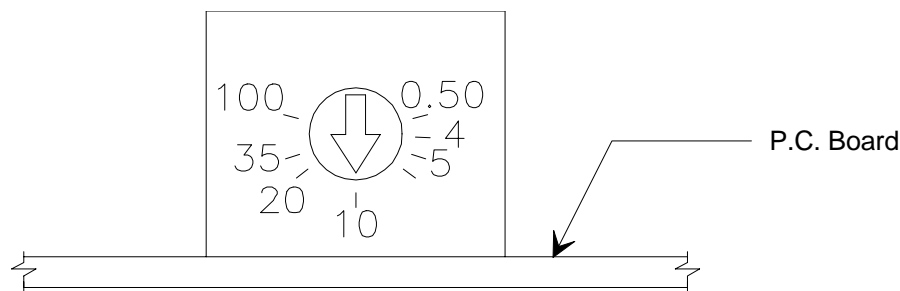

Figure 8: Process Limit Set Point Control

The PLO is usually shipped with the set points at 10%. However, the process limit set point should be set as required; 2 to 20% is typically used. Larger percentages will be required for noisy or fast changing systems.

To establish a precise process limit set point:

1. Input a stable signal (such as zero).
The error meter should read zero ($\pm 0.05\%$) when the controller set point is also at zero.
2. Increase the set point to the deviation at which the PLO is required to trip.
3. Adjust the process limit set point until the LED is just tripping.

Interconnections

Since there are a limited number of spare pins on the Interface connector, the exact pinout will depend on which options are installed. Some examples are listed in Table 9.

Process Limit Option Pinout			
Interface Connector Pin	#1 Standard Unit with PLO	#2 Multiple Set Point Option (MSO) and PLO	#3 MSO, PLO, and Valve Position Option (VPO) where valve position voltage is brought out
1	(+) Ext. Set Point		VPO (+10 V)
2	PLO Logic Output (+5 V)	PLO Logic Output (+5 V)	PLO Logic Output (+5 V)
3	Digital Ground	Digital Ground	Digital Ground
4	OPEN	OPEN	OPEN
5	CLOSE	CLOSE	CLOSE
6	PLO N.O. Relay	Set Point 1	Set Point 1
7	PLO N.C. Relay	Set Point 2	Set Point 2
8	(-) Ext. Set Point	(-) Ext. Set Point	(-) Ext. Set Point
9	PLO Relay Common	Set Point 3	Set Point 3
10		-Set Point 4	Set Point 4
11	+15VDC Supply	+15VDC Supply	+15VDC Supply
12	Power Ground	Power Ground	Power Ground
13	-15VDC Supply	-15VDC Supply	-15VDC Supply
14	Chassis Ground	Chassis Ground	Chassis Ground

Table 9: Process Limit Option Pinout

Note



1. The N.O. relay contact is CLOSED when the error signal is less than the Process Limit Set Point (that is, everything is normal). Relay contacts are rated to switch 0.25 Amps, 28 Volts resistive.
2. The logic input will source 1 mA (4700 ohms to +5 Volts) and will sink 10 mA to digital ground.
3. Digital ground (Pin 3) is the reference for the CLOSE, MANUAL, and EXTERNAL set point inputs and is also reference for the PLO output.

This page intentionally left blank.

Chapter Five: Maintenance and Troubleshooting

General Information

If the 250 instrument fails to operate properly upon receipt, check for shipping damage, and check the cables for continuity. Any damage should be reported to the carrier and MKS Instruments immediately. If it is necessary to return the unit to MKS, obtain an ERA number (Equipment Return Authorization Number) from a MKS Service Center before shipping. Please refer to the inside back cover of this manual for a list of MKS Calibration and Service Centers.

Maintenance

Periodically check for wear on the cables and inspect the enclosure for visible signs of damage.

How To Clean the Unit

Periodically wipe down the unit with a damp cloth.

How To Replace the Fuses

The line fuses protect the internal circuitry; both sides of the line are fused. The fuse values are:

115 VAC 0.50 A (T) / 250 V / 5 x 20 mm

230 VAC 0.25 A (T) / 250 V / 5 x 20 mm

Caution



Disconnect the line cord from the AC power outlet before replacing the fuse.

How To Perform the Controller Alignment Procedure

The following alignment procedure should be followed to verify the zero and full scale alignment of the 250 controller. Allow the controller to warm up for at least 30 minutes. Note that the main P.C. board has a block of test pins TP-1, 2, 3, etc. located behind the connector for the rear panel board.

Equipment Needed

- 0 to 10 volt source for input
- 100 ohm, 1 Watt resistor for load
- 4 and 1/2 place, 0 to 10 volt meter

Connections

1. Connect the input source to the INPUT connector Pins 1 and 8 (Pin 8 should also be connected to Pin 12).
2. Connect the 100 ohm resistor to the VALVE connector Pins C and D.
3. Verify that the controls are in the following positions:

SETPOINT POT	CCW (000)
SETPOINT INT/EXT	INT
RANGE	10V
PHASE LEAD	CCW
GAIN	CW
MODE	CLOSE
NORmal/REVerse	NORMAL
115/230 (Rear Panel)	As available

4. Verify that the A.C. supply is either 115 \pm 15 or 230 \pm 15 volts A.C.
5. Check the voltage at the test points listed in Table 10, page 41, and readjust the appropriate control if necessary.

Note



Ref (GND) at the test DVM should be the A GND test point next to C18.

Test Point Voltages			
Condition	Test Point	Voltage	Control
	(+) 15 V Supply Jumper	+ 15.00 ±.05	R118
	(-) 15 V Supply Jumper	- 15.00 ±.05	R125
Input = 0.000V	TP-6	0.000	Zero (R33)
Input = 0.000V	TP-1	0.000	Output Zero (R89)
Set point = 000	TP-11	0.000	S. P. Zero (R89)
Input = 0 Set point = 0	TP-5	0.000	D.A. Zero (R48)
Input = 0 Set point = 0	TP-10	0.000	Error Meter Zero (R95)
Input = 0 Set point = 0	TP-7	0.000	Lead Zero (R54)
Input = 0 Set point = 0	TP-4	0.000	Gain Zero (R66)
Input = 0 Set point = 0 Mode = AUTO	TP-3	Any voltage between 0 and +10 V, but it should hold steady	INT Zero (R73)
Input = 10.000V	TP-6	5.000 ±.002	SPAN (R41)
Input = 10.000V	TP-1	10.000	Signal SPAN (R91)
Setpoint = 1000	TP-11	5.000 ±.002	Setpoint Cal (R19)
TP-6 = TPB-11 (-5.000)	TP-5	0.000	Diff. Amp. Cal. (R130)
Input = 0 Setpoint = 010	Error Meter	1%	Meter Gain (R100)

Table 10: Test Point Voltages

Troubleshooting

To locate the cause of trouble, follow steps 1, 2, and 3 in sequence.

1. Check for obvious problems such as power off, open fuse, defective line cord, input power failure, or loose connections.
2. Check all control settings.

FRONT PANEL

Power	ON (Power light should be on)
Set Point	Switch on INT. Control at proper level
Input Select	As required (normally 10 V)
Phase	As required (normally 1 to 5 sec.)
Gain	As required (normally 100%)
Mode	AUTO or EXT

INSIDE

Nor/Rev	Normal
---------	--------

REAR PANEL

115/230	As required by AC power supply
---------	--------------------------------

3. Determine the probable cause from the Troubleshooting Chart (refer to Table 11, page 43).

Troubleshooting Chart	
Symptom	Checks and Probable Causes
<p>Error Meter shows oscillation or noise (Optional DVM reading is noisy)</p>	<ul style="list-style-type: none"> a. Check to see if input gas pressure is steady. b. Check that pressure transducer has a steady output (vibration isolation may be required). c. Check that diffusion pump is not choking. Refer to <i>System Design</i>, page 14. d. Readjust PHASE and/or GAIN controls. Refer to <i>How To Tune-Up the Controller</i>, page 30.
<p>Error Meter shows steady error greater than $\pm 0.25\%$ (Optional DVM reading does not agree with set point)</p>	<ul style="list-style-type: none"> a. Increase GAIN setting. Refer to <i>How To Tune-Up the Controller</i>, page 30. b. If reading is higher than set point, try lowering BIAS. c. If reading is lower than set point, check that incoming gas supply is adequate. d. Check valve operation in Manual mode. e. If mode control is in EXT, remote controller may be overriding. Remove Interface connector to verify. f. Check that Normal/Reverse switch (inside) is set correctly (usually NORMAL). g. Check that set point input is correct.
<p>Error Meter shows error less than 0.25% but pressure is not correct</p>	<ul style="list-style-type: none"> a. Check that Power is ON. b. Check that pressure transducer signal is proportional to pressure. c. Trouble in Amplifier or Set Point Amplifier.

Table 11: Troubleshooting Chart

This page intentionally left blank.

Appendix A: Product Specifications

CE Mark Compliance	
Electromagnetic Compatibility ¹	EMC Directive 89/336/EEC
Low-Voltage Requirements	Low-Voltage Directive 73/23/EEC
Installation Category	II, according to EN 61010-1
Pollution Degree	2, according to IEC 664
Product Safety and Liability	Product Safety Directive 92/59/EEC
External Set Point	0 to 5 VDC analog (40K load impedance)
Fuse Ratings	
115 VAC	0.50 A (T) / 250 V / 5 x 20 mm
230 VAC	0.25 A (T) / 250 V / 5 x 20 mm
Input Commands	CLOSE and MANUAL
Input Signal	0 to 10 VDC, 0 to 1 VDC, or 0 to 0.1 VDC (switch selectable on front panel)
Operating Temperature	0° to 40° C (32° to 104° F)
Output Power	+ and - 15 ±0.6 VDC @ 250 mA maximum
Power Consumption	50 VA maximum (50/60 Hz)
Power Requirement	
115 VAC Setting	100 to 120 VAC nominal
230 VAC Setting	220 to 240 VAC nominal
Regulation	±0.25% of full scale
Valve Outputs	
Current	0 to 120 mA
Voltage	0 to 110 VDC
Voltage Outputs	
Input signal	0 to 10 Volts (5K min. resistance)
Controller output	0 to 10 Volts (5K min. resistance)

Due to continuing research and development activities, these product specifications are subject to change without notice.

¹An overall metal braided shielded cable, properly grounded at both ends, is required during use.

This page intentionally left blank.

Appendix B: Model Code Explanation

Model Code

The desired instrument options are identified in the model code when you order the unit.

The model code is identified as follows:

####-X-Y-Z

where:

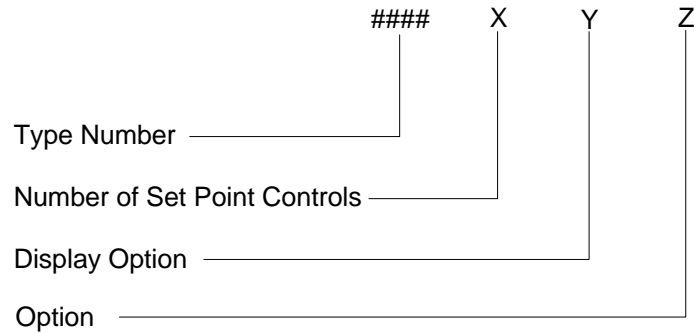

Type Number (####)

This designates the model number of the instrument. The controller is identified as the Type 250E.

Number of Set Point Controls (X)

Three types of set point control (multiple set point option) are available, designated by a single number code.

	Ordering Code
Standard: single set point control	1
Optional: three set point controls	3
Optional: four set point controls	4

Display Option (Y)

Two types of displays are available, designated by a single letter code.

	Ordering Code
Standard: Analog Error (Deviation) Meter	A
Optional: 4½ Place Digital Display (of input signal)	D

Option (Z)

One functional option is available, designated by a three letter code.

	Ordering Code
Process Limit Option	PLO

Index

C

Cables, 10

Connectors

 interface, 26

Customer support, 7

I

Installation Category, 13

L

Labels, 27

M

Manual organization, 7

Messages, definitions of, 4

Model code, 47

O

Operation

 bias control, 31

 dvm option, 33

 external control, 32

 initial setup, 29

 manual control, 30

 multiple set point option, 34

 normal/reverse switch, 32

 process limit option, 36

 tune-up, 30

P

PCS, 23

Pollution Degree, 13

Pressure control signal, 23

R

Returning the product, 7, 9

S

Serial number label, 27

Setup

 controller, 16

 interconnections, 17

 mass flow meter, 17

 system design, 14

 transducer, 17

 valve, 16

Span adjustment, 24

T

Temperature, 13

Troubleshooting, 42